

HP Archive

This vintage Hewlett Packard document was preserved
and distributed by

[www. hparchive.com](http://www.hparchive.com)

Please visit us on the web !

On-line curator: Glenn Robb

This document is for FREE distribution only!

AUTOMATIC SIGNAL MONITORING USING SPECTRUM ANALYZER-BASED RECEIVER SYSTEMS

SIGNAL ANALYSIS DIVISION
1212 VALLEY HOUSE DRIVE
ROHNERT PARK, CA 94928

AUTHOR:
CARLA McCARTER

**RF & Microwave
Measurement
Symposium
and
Exhibition**

 **HEWLETT
PACKARD**

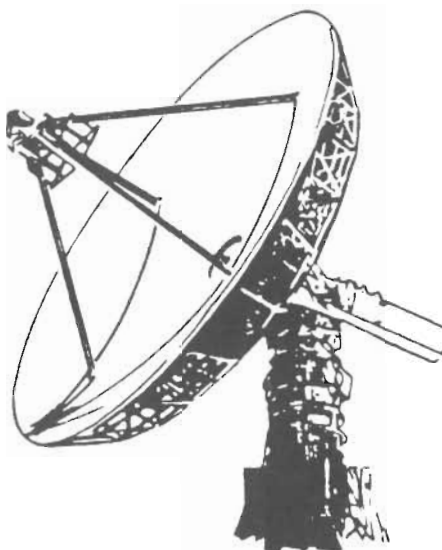

AUTOMATIC SIGNAL MONITORING USING A SPECTRUM ANALYZER RECEIVER SYSTEM

A spectrum analyzer is a broadband, extremely sensitive, programable, swept-tuned, superhetrodyne receiver with display capability. Because of these features, it is an excellent receiver to analyze transmitted signals. This paper gives an overview of the hardware and software which make up a Automatic Signal Monitoring Receiver (SIGMON) System for a wide range of measurement applications. Further topics discussed are the measurement capabilities of the SIGMON system for monitoring frequency bands, analyzing signals, measuring signal parameters (amplitude, frequency, modulation type, pulse width, pulse repetition frequency, power bandwidth etc.), performing statistical summaries, aid in generating reports of measured data, and many other incorporated features.

AUTOMATIC SIGNAL MONITORING WITH A SPECTRUM ANALYZER RECEIVER SYSTEM



Today's presentation on "Automatic Signal Monitoring with a Spectrum Analyzer Receiver System" will address the following questions: What application areas of signal monitoring can be addressed with a spectrum analyzer? What are the limitations of a spectrum analyzer based Signal Monitoring Receiver System? What are specific features of the system (hardware/software) that make it attractive to a user? We will also cover any specific questions you may have.

TOPICS

- Applications Overview
- Receiver System Hardware
- Application Characteristics
 - Example
 - Receiver Requirements
 - System Features
- Additional System Features

Following a general overview of application areas in signal monitoring, we will discuss the generic superheterodyne receiver as it is used for signal monitoring operations. Then, we will introduce the hardware and software that is or can be used to configure an Automatic SIGNAL MONitoring (SIGMON) Receiver System. Due to the variety of measurement and hardware requirements, we will show specific features and limitations of the system in each application area. We will then conclude by summarizing general SIGMON Receiver System features that apply to all aspects of signal monitoring.

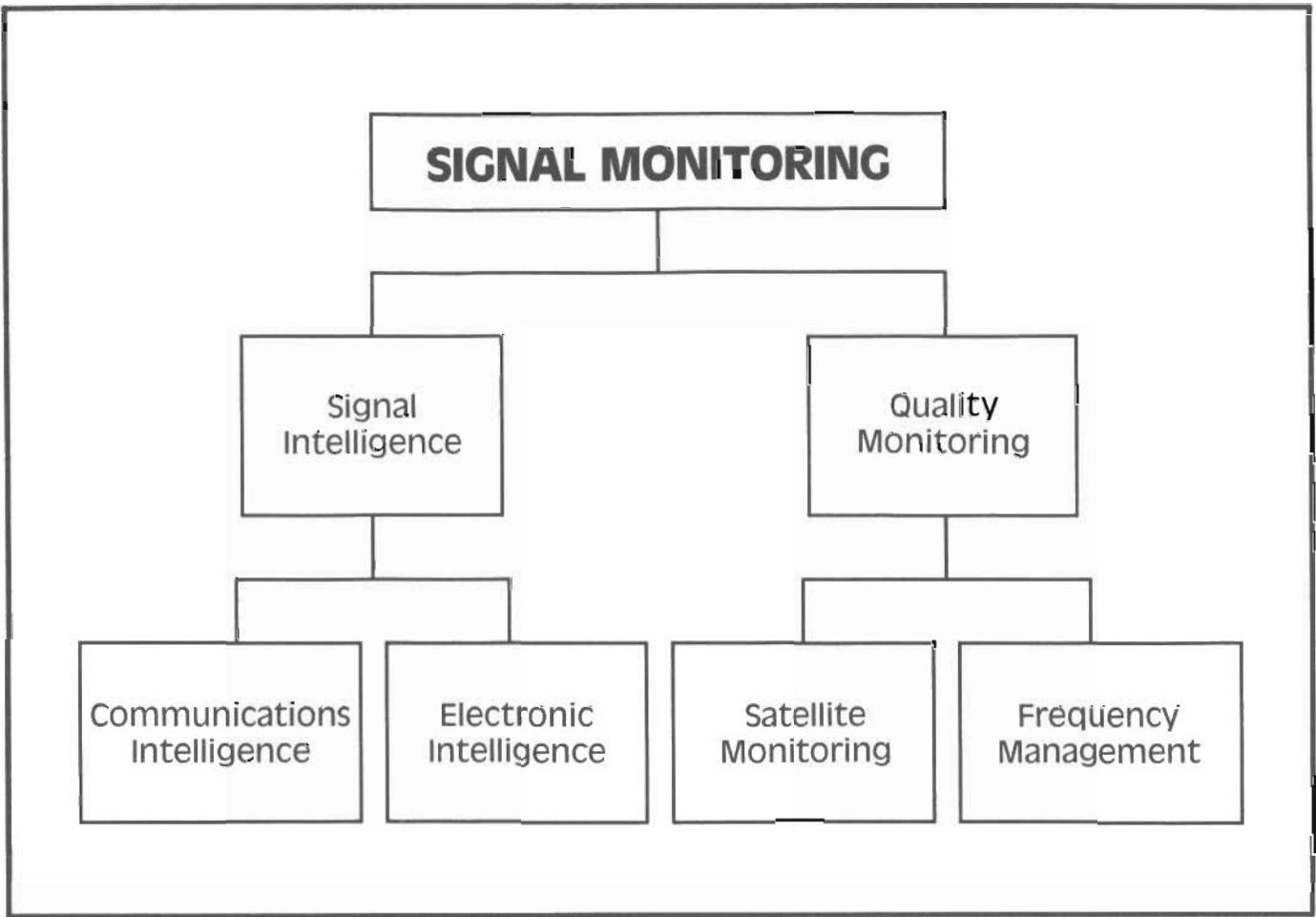

SIGMON applications can be divided into two areas: Signal Intelligence (SIGINT) and Quality Monitoring. These two categories can be further divided into sub-categories. Under SIGINT, Communications Intelligence (COMINT) involves "listening" to communication signals, and Electronic Intelligence (ELINT) involves the analysis and identification of non-communication signals—namely, radars and jammers. Quality Monitoring is divided into Satellite Monitoring (SATMON), which involves maintaining satellite transmission systems, and Frequency Management, which studies signals for the purpose of allocation, regulation, and usage of the frequency spectrum.

SUPERHETERODYNE SIGMON RECEIVER SIMPLE BLOCK DIAGRAM

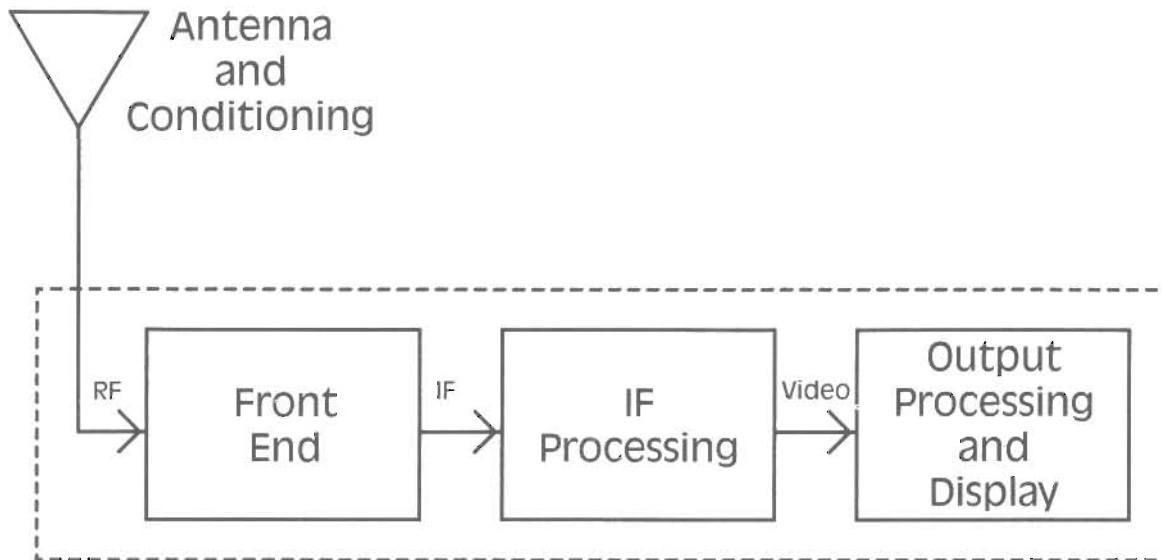

There are different types of receivers on the market today, each with specialized characteristics best-suited for a particular application. Although a particular application may require that one of these specialized receivers be used, in general, a superheterodyne receiver contains the elements necessary for most signal monitoring applications. Since a spectrum analyzer is a superheterodyne receiver, we will concentrate on how a spectrum analyzer can be used in each one of the four signal monitoring categories just presented.

A superheterodyne receiver system contains the following pieces: an antenna/preamplification network to pick the signals out of the airwaves with a low-noise preamplifier to boost the input signal level; a broadband RF, microwave, or millimeter front-end to translate the input signal to an intermediate frequency (IF) for signal processing; an IF processing section to extract signal information and measure signal parameters; and, finally, an output device so the signal information can be viewed, analyzed, or "massaged" into some viable output form.

TYPICAL SPECTRUM ANALYZER RECEIVER SYSTEM

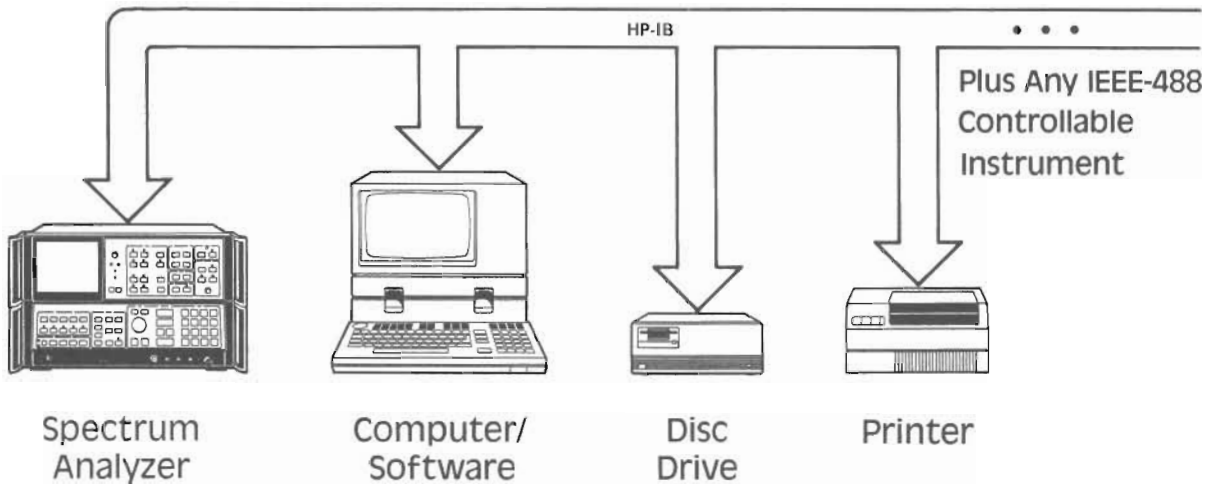

The heart of the automatic signal monitoring receiver system is one of the high-performance Hewlett-Packard spectrum analyzers (HP 8567A, 8566B, or 8568B). Because these spectrum analyzers are broadband, extremely sensitive, programmable, and swept-tuned, and because they have a dynamic display, they make excellent receivers for the analysis of transmitted signals.

Automating the spectrum analyzer and customizing its measurements for spectrum monitoring and broadband surveillance applications, is the HP 85865B Signal Monitoring Software. The software, which runs on an HP Series 200 or Series 300 controller, is a command driven program written in Pascal. Throughout today's presentation, we will discuss specific features of the software in relation to different applications and then focus on some additional system features that apply to general signal monitoring.

In addition to the spectrum analyzer, controller, and software, the SIGMON Receiver System also supports peripherals such as printers and plotters. Other hardware instruments supported are the HP digitizers and digitizing oscilloscopes, the HP waveform recorders, and the HP 85685A RF Preselector. In addition, virtually any IEEE-488 controllable instrument can be added to the SIGMON Receiver System to customize it for a particular measurement.

The minimum hardware/software configuration for the Automatic SIGMON Receiver System is a controller, disc drive, software, and spectrum analyzer. The typical cost for a system is about \$100K.

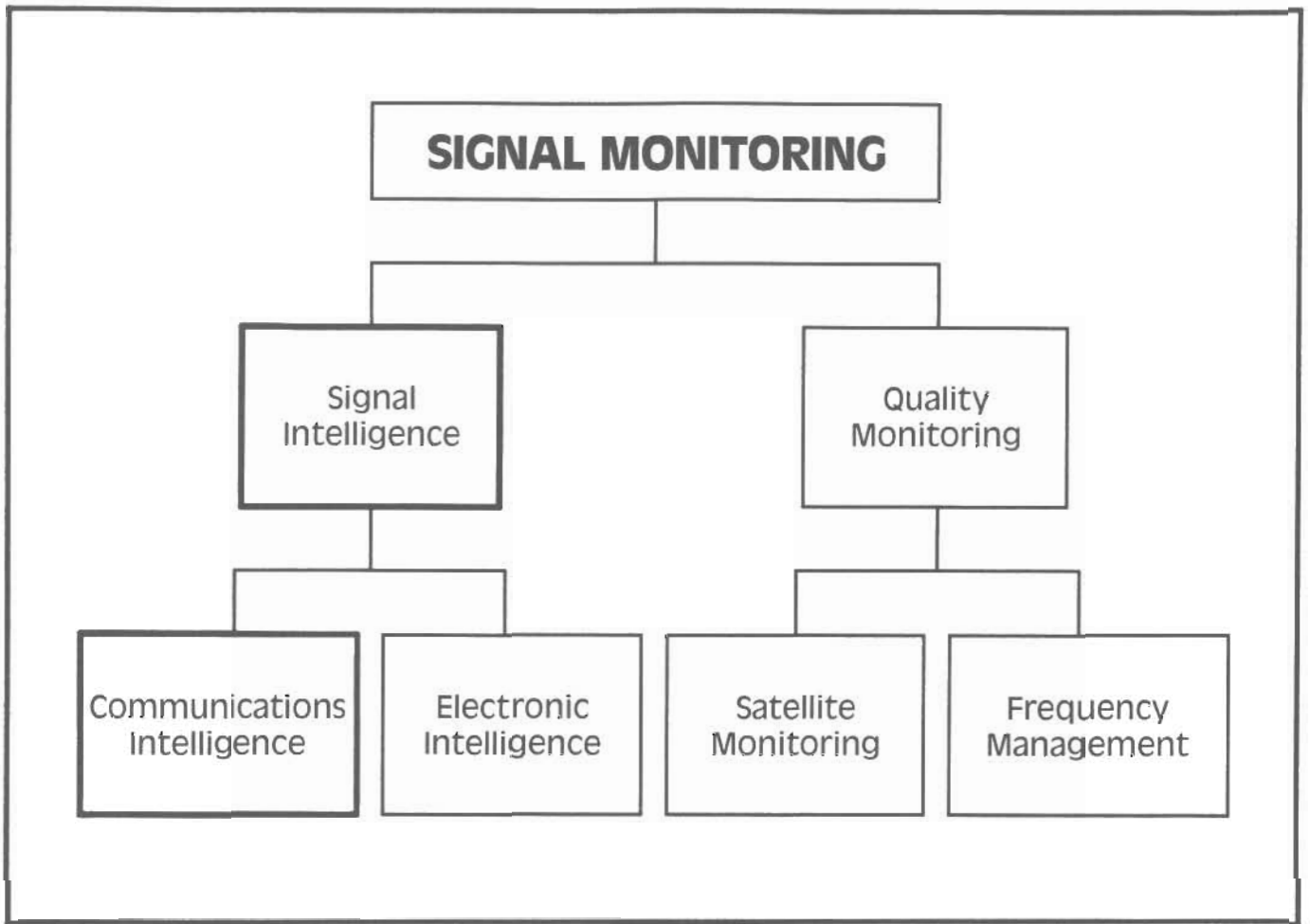

Let's first concentrate our attention on SIGINT applications of signal monitoring, specifically COMINT measurements

COMMUNICATIONS INTELLIGENCE

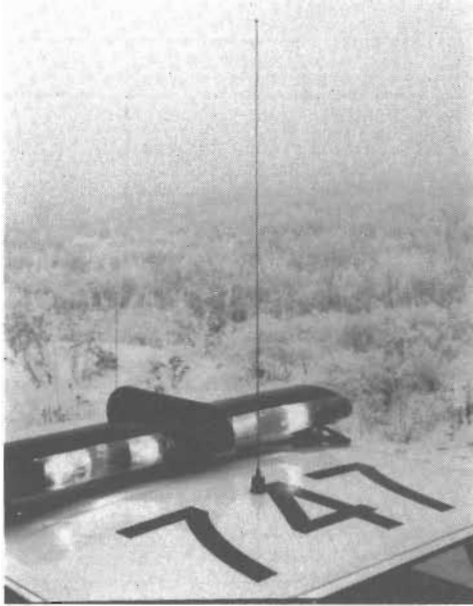

Key Measurements

- Intercept the Signal(s)
- Demodulate
- Record and/or Listen

People involved with COMINT are generally interested in "listening" to communication signals. To perform this task, the transmitted signal must first be intercepted by the receiver, demodulated, and recorded or output to a speaker, in order to determine whether the signal is of interest. If the signal is of interest "direction finding" may be required to pinpoint the source of the transmission.

For example, many people involved in illegal activities (e.g. terrorists, drug traffickers) transmit messages through the airwaves to avoid being discovered over wire-tapped telephones. A government surveillance agency would be interested in monitoring the airwaves in hopes of detecting such transmitted signals. This would involve measuring signal characteristics to determine whether a two-way conversation was in progress, listening to the transmitted conversation, discovering where the transmission was coming from, and ultimately arresting the guilty parties.

COMMUNICATIONS INTELLIGENCE RECEIVER REQUIREMENTS

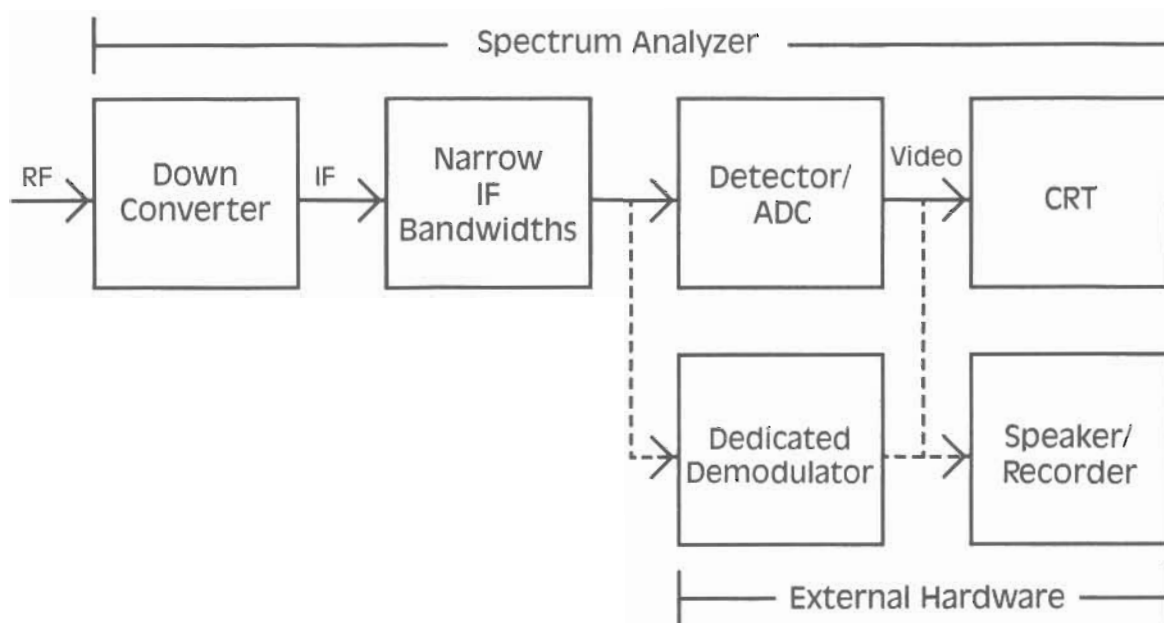

We have now expanded our general block diagram of a superheterodyne receiver into the specific stages required to create a COMINT receiver. Notice the spectrum analyzer acts as an excellent front-end to downconvert an input signal to an IF. The adjustable IF bandwidths enable the analyzer to individually resolve input signals and limit the amount of noise processed through the remaining stages of the receiver. Although a spectrum analyzer does provide a detection scheme in which signal identification can be estimated, a dedicated demodulator may be required. The IF frequency out of the IF bandwidth filters (located on the rear of each spectrum analyzer) can be routed to a demodulator for the necessary processing. The final stage in the COMINT receiver, the output processing and display, can be provided by the spectrum analyzer's CRT or the video signal from the analyzer can be routed to an external speaker/recorder. Thus, although the spectrum analyzer may have certain hardware limitations in this application, when dedicated demodulation is required, the analyzer provides a way to interface with a demodulator to provide the desired results.

Now let's take a look at some specific features in the SIGMON receiver that will help a COMINT user.

DYNAMIC DISPLAY

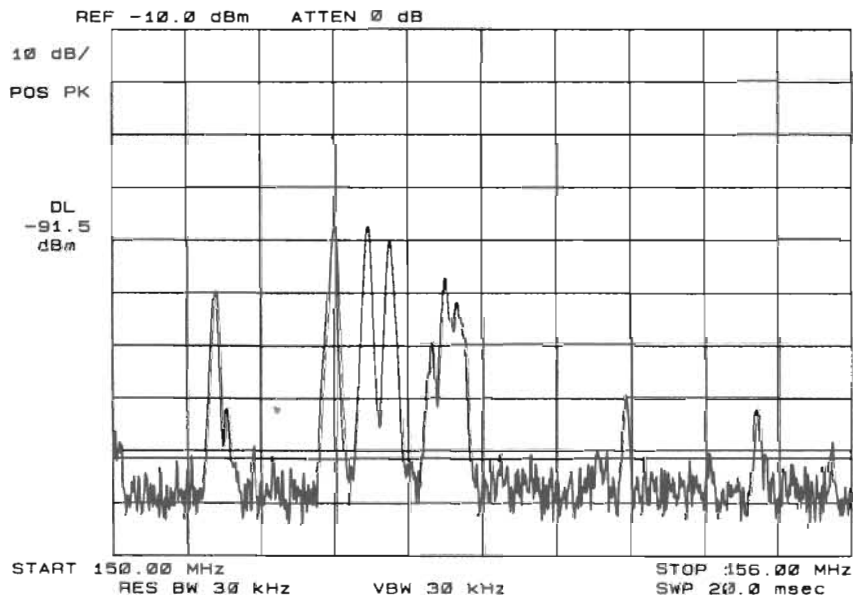

The fact that the spectrum analyzer has a swept, dynamic CRT display is a real benefit to the COMINT user. It is very difficult to find a transmitted signal and listen to that transmission if you have no way of quickly determining the frequency of the signal. The CRT display provides this window to the airwaves so that signal activity can be viewed.

"DEMODULATE" AND ESTIMATE MODULATION TYPE

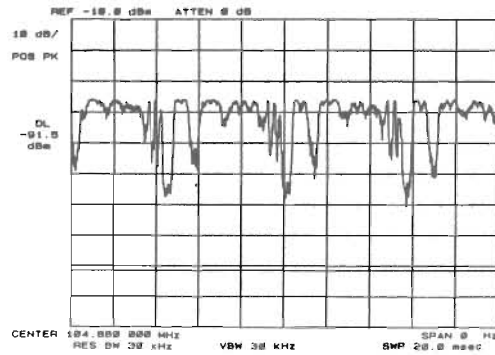

CRT 0 Span

```
*****
RUN TITLE : CHANNEL X
DATE      : 8/13/85      RUN MODE : ANALYSIS
*****
```

TIME	FREQ MHz	PWR dBm	MOD
20:38:49	104.000	-35.8	FM
20:38:50	104.000	-35.6	FM
20:38:50	104.000	-35.8	FM
20:38:50	104.000	-35.7	FM
20:38:50	104.000	-35.9	FM
20:38:51	104.000	-35.8	FM
20:38:51	104.000	-35.7	FM
20:38:51	104.000	-35.7	FM
20:38:51	104.000	-35.9	FM
20:38:51	104.000	-35.9	FM
20:38:51	104.000	-35.9	FM
20:38:51	104.000	-35.9	FM
20:38:51	104.000	-35.9	FM
20:38:52	104.000	-35.9	FM
20:38:52	104.000	-36.0	FM
20:38:52	104.000	-35.9	FM

WRT SIG

Although we have seen in the superheterodyne receiver block diagram that the spectrum analyzer does not have dedicated demodulation capability, the fixed-tuned mode of the analyzer, coupled with the SIGMON software, does offer a way to "demodulate" a signal and estimate the modulation type. It is in the fixed-tuned mode that a speaker can be connected to the video output of the spectrum analyzer for listening purposes.

WHO IS TALKING TO WHOM?

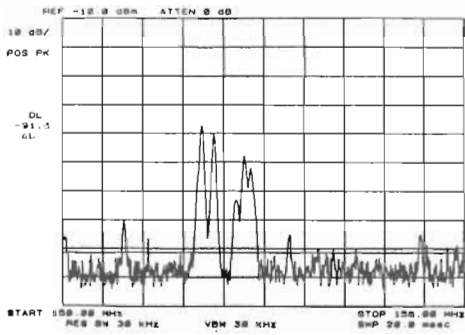

CRT Trace

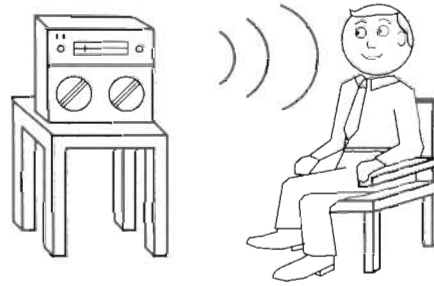

Speaker

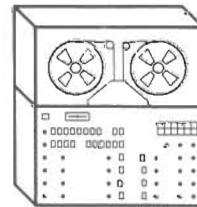

Recorder

One important measurement to a COMINT user is detecting two-way communications. While a CRT display, audio speaker, and voice recorder provide the ability to see signal activity in a band at a given time, listen to what is being said, and record conversations, respectively, there is no way to easily view signal activity in a band versus time.

VIEW SIGNAL ACTIVITY VS. TIME

TIMEGRAM OUTPUT FORMAT (INTERCEPTS VS FREQUENCY)

MOBILE 1

DATE: 8/13/86, TIME:20:47:20:76

10 SEC/DIV

150.000 MHz

156.000 MHz

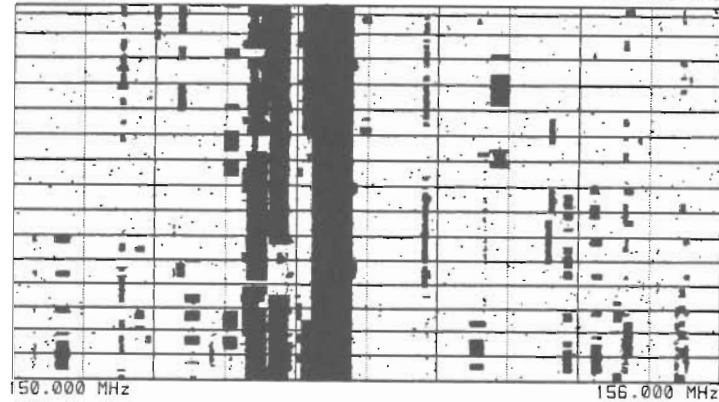

The SIGMON software provides "timegram" plots that depict signal activity versus time. On the horizontal axis are the start and stop frequencies of the band being monitored. The vertical axis plots time beginning with zero seconds at the top and progressing downward as a function of time. The timegram plot can be directly output to a printer or the controller console screen. Some signal types that can be identified using the timegram plot are two-way communications, spread spectrum (frequency hopped) signals, and keyed signals.

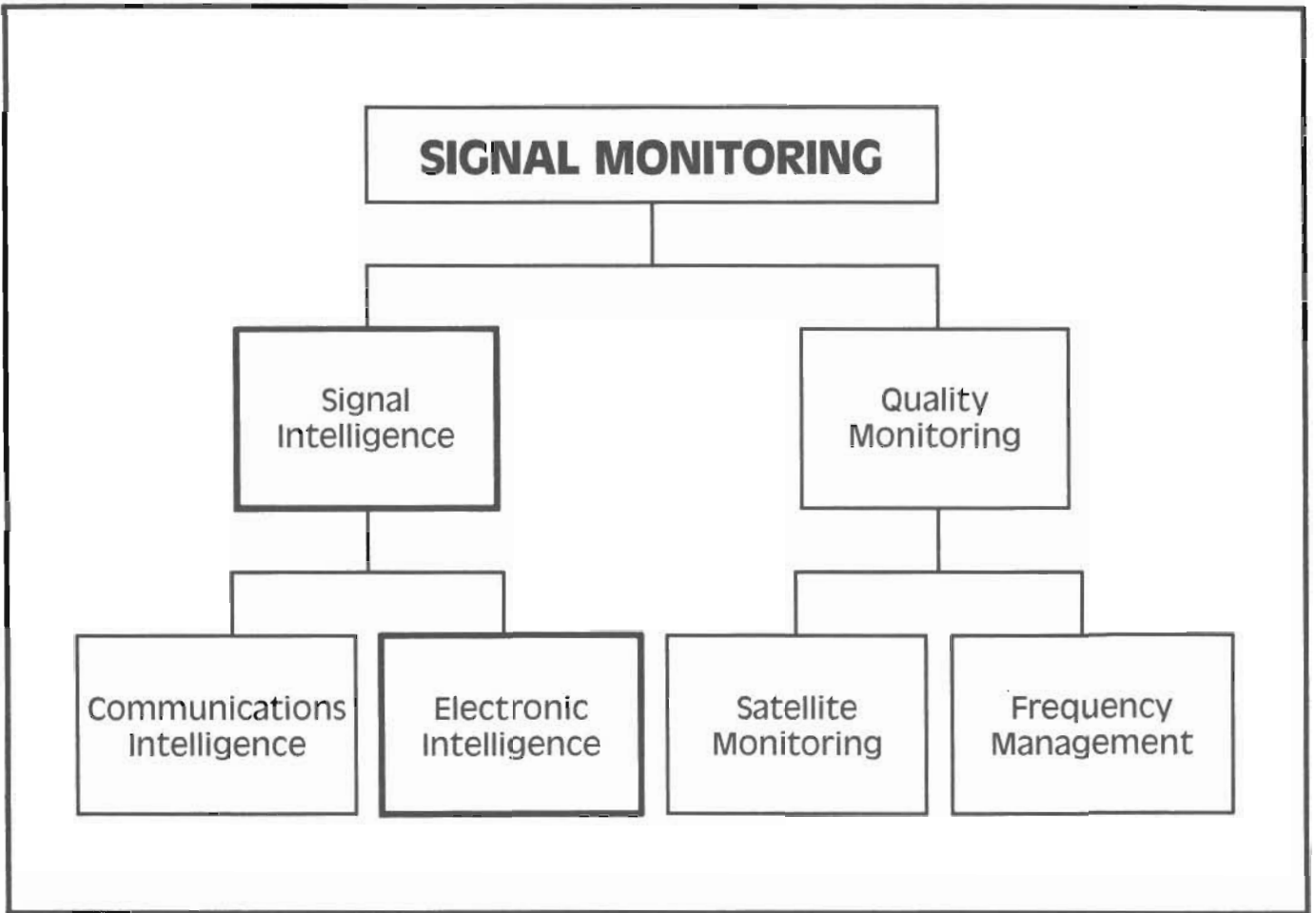

The second area of SIGINT applications is ELINT. Let's now focus on ELINT measurements.

ELECTRONIC INTELLIGENCE



Key Measurements

- Intercept the Signal
- Measure Pulse Parameters
 - Center Frequency
 - Power
 - Pulse Width
 - Pulse Repetition Interval
 - Antenna Beamwidth
 - Antenna Rotation Rate

ELINT measurements involve the analysis of radar type signals. The ELINT analyst attempts to reverse the radar design process and infer the radar's capabilities by observing the radar signal and measuring its parameters. The ELINT analyst also goes one step further. By examination of the radar's signal characteristics, an attempt is made to identify radar sets and to determine the level of technology used in building the radar set. Finally, ELINT helps find weaknesses in the radar to permit future tactical electronic countermeasures (ECM).

ELECTRONIC INTELLIGENCE RECEIVER REQUIREMENTS

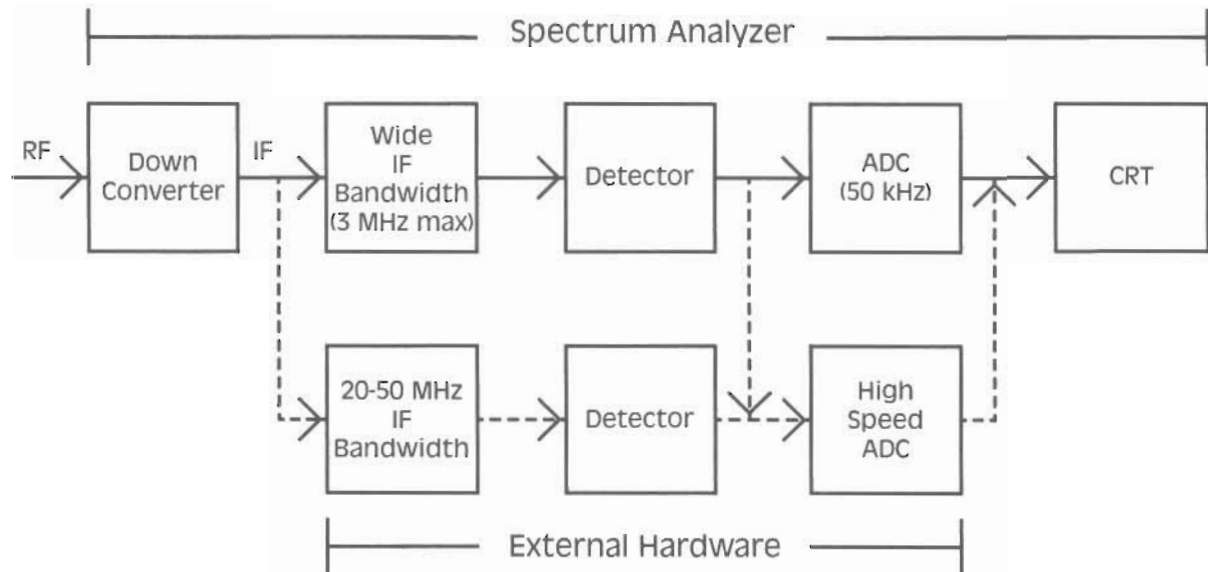

Again, we have expanded our general block diagram of a superheterodyne receiver into the specific stages required for an ELINT receiver. We are not suggesting that a swept-tuned receiver will act as a tactical radar warning receiver, where the probability of intercept (POI) must be close to 100%. The swept-tuned receiver is actually used as a strategic long-term data logging tool to provide preliminary information on radars and jamming systems. However, the superheterodyne receiver has two outstanding features which are advantageous in ELINT applications: high sensitivity and selectivity. High sensitivity allows interception of low-level signals such as radar sidelobes, thus eliminating the need for coincidence between the ELINT receiver and the radar signal of interest. High selectivity helps eliminate interfering signals which may impede measurement of the desired radar signal.

Notice again that the spectrum analyzer provides an excellent front end for an ELINT receiver. The IF filter bandwidth in the analyzer, typically 3 MHz maximum, does limit the ability of the analyzer to measure pulse widths narrower than 1 microsecond. If this pulse width limitation poses a problem, external hardware can be connected to the first IF stage to bypass the internal chain in the spectrum analyzer. The video signal can then be input to an HP digitizer/waveform recorder and back into the spectrum analyzer so that the display of the analyzer can be used to display analyzer data or video data.

Although in the ELINT arena, the spectrum analyzer may have hardware limitations (i.e., a need for wider bandwidth IF filtering and faster digitizing rates), a cost conscious user can use the SIGMON Receiver System with external hardware in order to provide the required measurement specifications.

Now let's look at some specific aspects of the SIGMON system which make it attractive in ELINT applications.

IDENTIFY PULSE SIGNALS AND MEASURE PULSE PARAMETERS

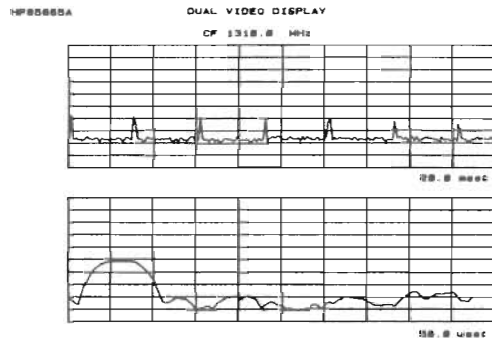

Dual Video Display

SIGNAL PARAMETERS
DATE 8/13/86
TIME 21:52:16:50

CENTER FREQ = 1310.000 MHz
AVER POWER = -88.1 dBm
PEAK POWER = -57.3 dBm
MAX POWER = -42.4 dBm
MOD FORMAT = PULSE
ARR = 5.0 RPM
ABW = 2.0 Deg
PRI = 3040.0 usec
PW = 5850.0 nsec

Parameter Summary
Display

The SIGMON receiver system (including the HP digitizer/waveform recorder) can perform the following ELINT measurements after the signal has been intercepted and identified a pulsed signal: frequency, average power, peak power, maximum power, pulse width, pulse repetition interval, antenna rotation rate, and antenna beamwidth.

STATISTICALLY IDENTIFY RADAR TYPES

```

RUN TITLE : ASR-7 6-POSITION STAGGER PRF
OPERATOR  : RJA          RUN MODE : ANALYSIS
DATE     : 8/26/86
TIME    : 11:13:41:54
    
```

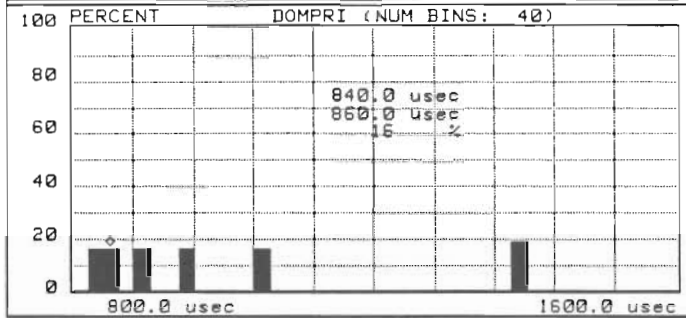

Histograms are a useful way for the ELINT analyst to display the relative distribution of measured parameter values. The horizontal axis of the histogram is the parameter of interest. The range of the parameter is divided into intervals called bins. By counting the number of occurrences of the parameter in each bin and plotting this as a function of the percentage of total samples, the histogram plot is obtained. The level of each bin represents the probability that the measured parameter will be in that bin.

For example, pulse repetition interval (PRI) histograms are useful in determining the overall statistics of the PRI sequence. A six-position staggered PRI histogram would show six spikes with equal bin heights. A sinusoidal-varying PRI would show the classic probability distribution function of a sine wave. To the ELINT analyst, histograms are very important for characterizing a radar signal.

DOES YOUR RADAR MEET SPECIFICATION?

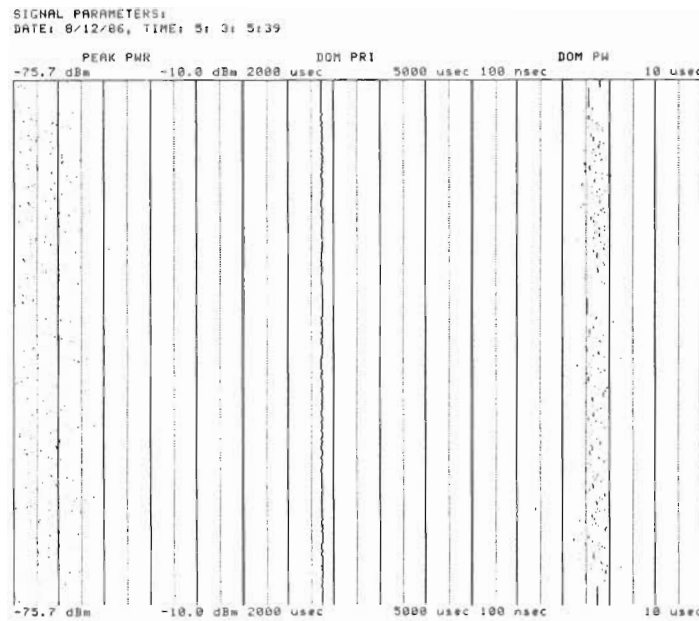

We've been concentrating on how the SIGMON receiver system can be used to characterize radar signals in an ELINT environment. But, it can also be used to perform radar and electronic warfare systems performance testing. Systems can be automatically monitored as they are run through test scenarios on stationary, mobile, or airborne platforms. Detailed analyses can be performed on individual pulses. This type of testing, made on prototype hardware or during periodic system performance checks, allows comparison of actual system performance to design specifications. The parameter sequence display plots various measured parameters (selected by the user) on the horizontal axis and plots time on the vertical axis. This allows observation of measured parameter variation over time.

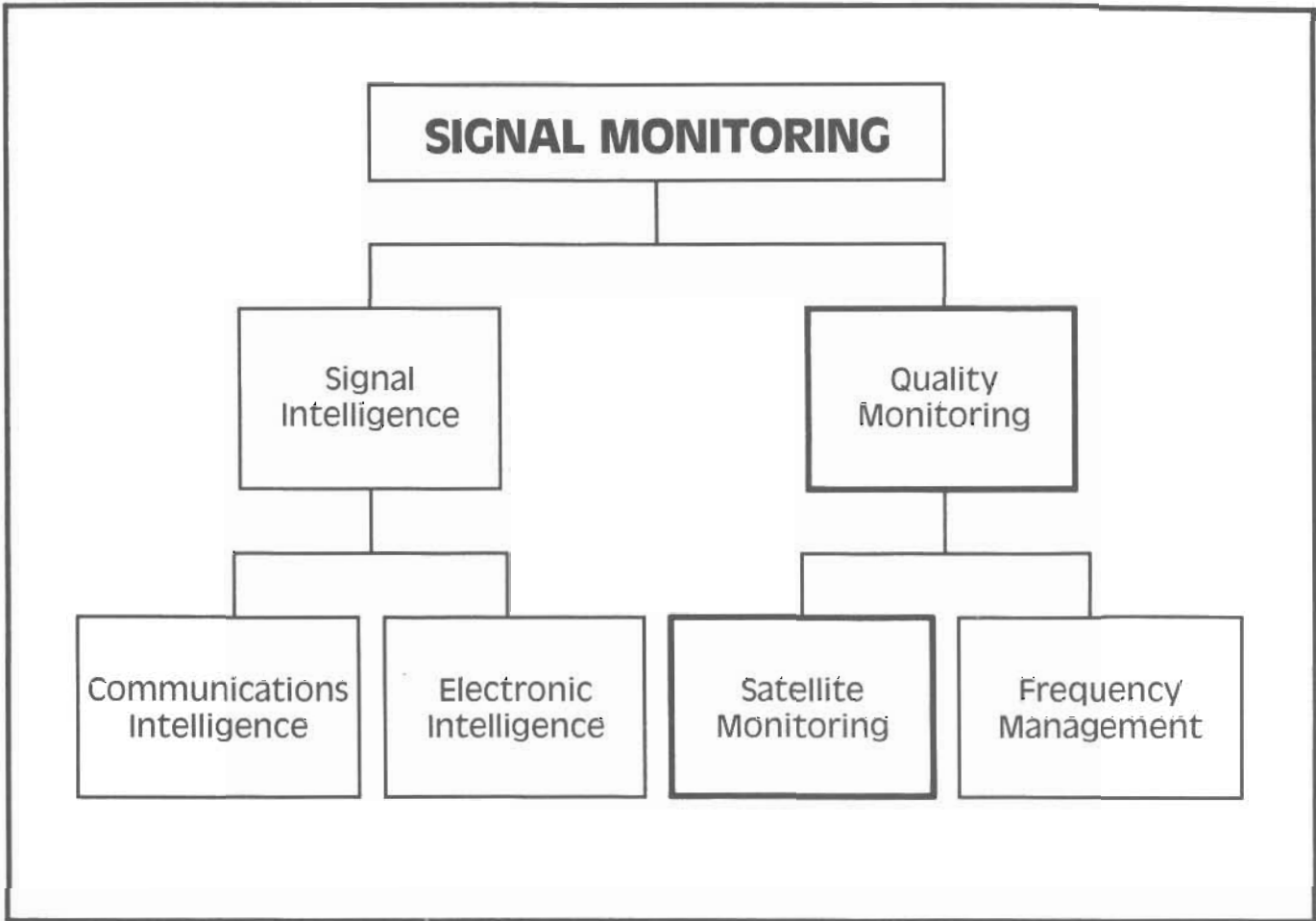

Now let's turn to Quality Monitoring applications, starting with satellite monitoring.

SATELLITE MONITORING

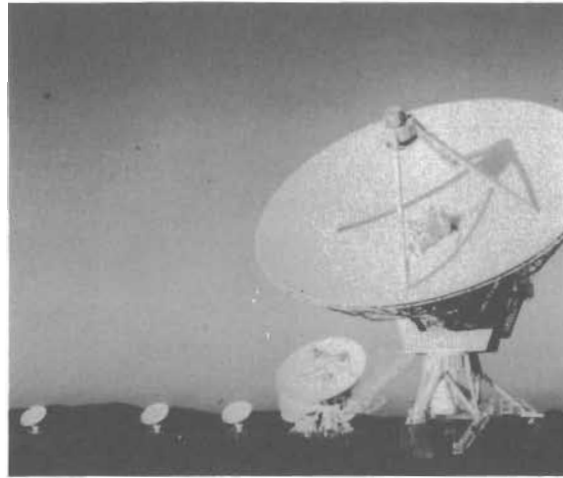

Key Measurements

- Carrier Frequency
- Signal to Noise Ratio
- Transmission Bandwidth
- Foreign Carrier Intrusion

Satellite Monitoring is exactly that—monitoring satellite transmissions. The people interested in satellite monitoring are not necessarily the satellite manufacturers but those who have leased transponder channel(s) on a satellite or who have final ownership of the satellite and therefore responsibility to guarantee transmission quality to their customers. The key measurements required in satellite monitoring are to monitor the carrier frequency and power level; measure the quality of the transmission (signal-to-noise ratio); verify that the transmission bandwidth hasn't been exceeded; and detect foreign carrier intrusions.

For example, if one of the carriers on a satellite is exceeding its transmission allocation, the spillover bandwidth, caused by overdriving the output amplifiers, may be degrading the transmission quality of adjacent channels. The problem must first be detected through constant monitoring of all channels by an earth station, and the offending party must then be notified.

SATELLITE MONITORING RECEIVER REQUIREMENTS

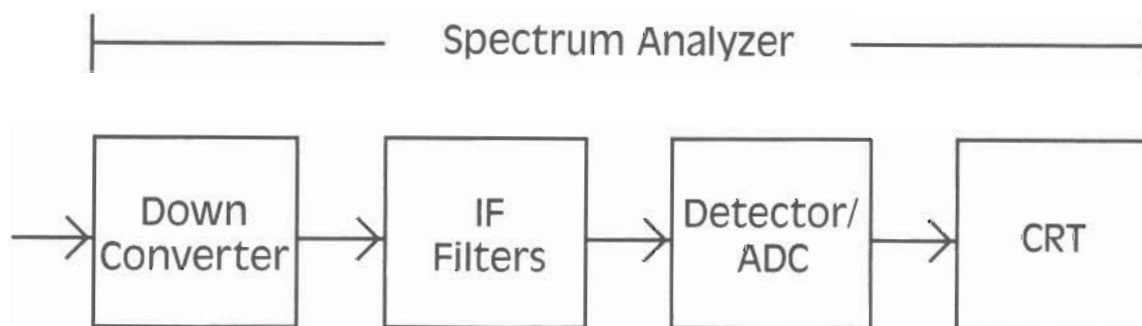

The SIGMON receiver system (both spectrum analyzer and software) provides a total satellite monitoring measurement solution. Let's see how the combination of spectrum analyzer and SIGMON software solves the measurement needs of an automatic satellite monitoring receiver.

MONITOR MULTIPLE CHANNELS

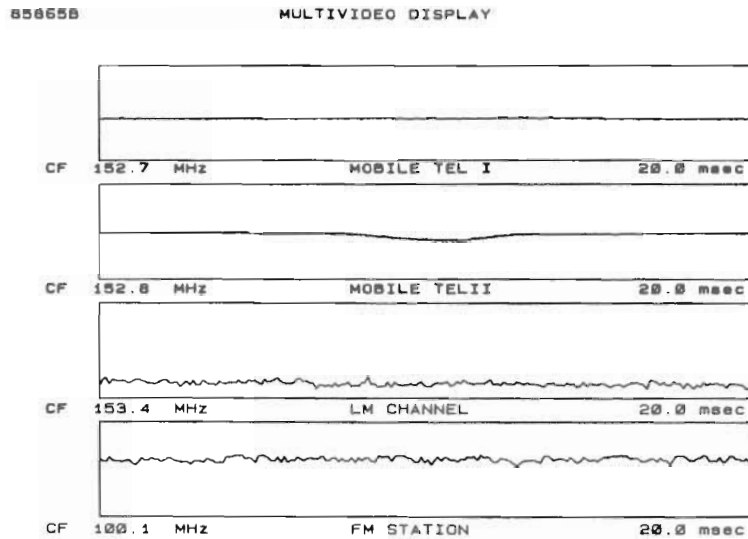

Multi Channel (O Span) Display

The SIGMON software allows "n" channels to be monitored sequentially (where "n" is a user defined parameter). In addition, the graphics capabilities of the high performance spectrum analyzers enable a user to see up to four different display channels at one time on the analyzer's CRT. Although the graphics trace must be compressed, all the measurement resolution of the spectrum analyzer is still intact.

SELECTIVE DATA REPORTING

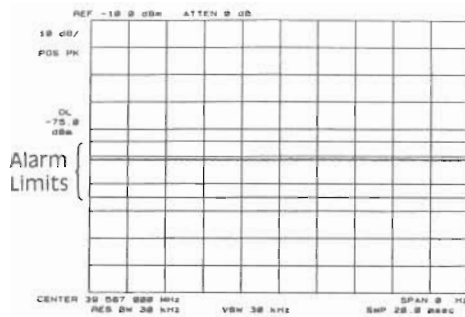

CRT Trace, 0 Span

DATE 8/14/86		ALARM MATCH DATA		
TIME	TYPE	FREQ	VALUE	
0:25:15:94	AMP	39.587 MHz	-54.7	dBm
0:25:16:0	AMP	39.587 MHz	-54.6	dBm
0:25:16:22	AMP	39.587 MHz	-54.6	dBm
0:25:17:72	AMP	39.587 MHz	-76.9	dBm
0:25:17:86	AMP	39.587 MHz	-76.7	dBm
0:25:18:0	AMP	39.587 MHz	-76.8	dBm
0:25:18:24	AMP	39.587 MHz	-76.7	dBm
0:25:18:47	AMP	39.587 MHz	-76.9	dBm
0:25:23:52	AMP	39.587 MHz	-76.7	dBm
0:25:23:76	AMP	39.587 MHz	-76.9	dBm
0:25:24:0	AMP	39.587 MHz	-76.9	dBm
0:25:24:24	AMP	39.587 MHz	-76.7	dBm
0:25:24:48	AMP	39.587 MHz	-76.7	dBm

Alarm Match Data

While the carrier frequency is usually known for a given satellite channel, the power level must be monitored constantly to detect any problems in the satellite system. The SIGMON software lets an operator monitor signal power to ensure that the transmitted signal falls within specified tolerances. In this example, an amplitude window is set around the power levels. If the transmitted power falls anywhere outside the limits set, the system reports the time and date of the problem's occurrence. This reporting can be done totally under automatic control, twenty-four hours a day, thus freeing up a dedicated operator for other tasks.

IS ANYONE ELSE USING YOUR SATELLITE CHANNEL?

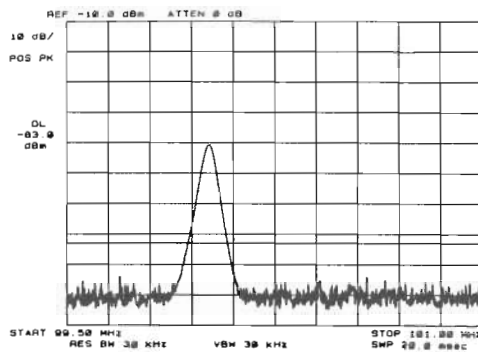

"Mask" Known Carrier

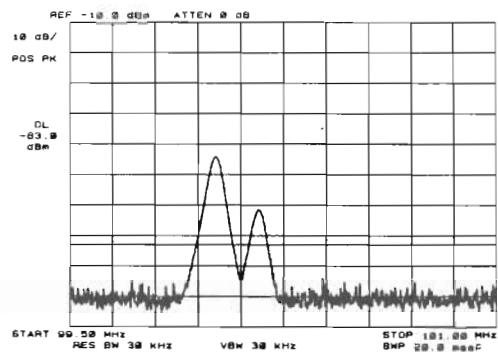

Set Frequency Alarm

In order to detect foreign carrier intrusion or unauthorized transmissions on a channel, the known carrier can be "masked" from all reporting in the software (those signals that the system is aware of are placed in a "known signals list"). Alarm limits can then be set by frequency, covering the allocated transmission bandwidth. If an unauthorized carrier is detected, the system administrator can be notified by a beep, a snapshot of the spectrum can be stored for later review, and printouts can be made on the controller console or system printer.

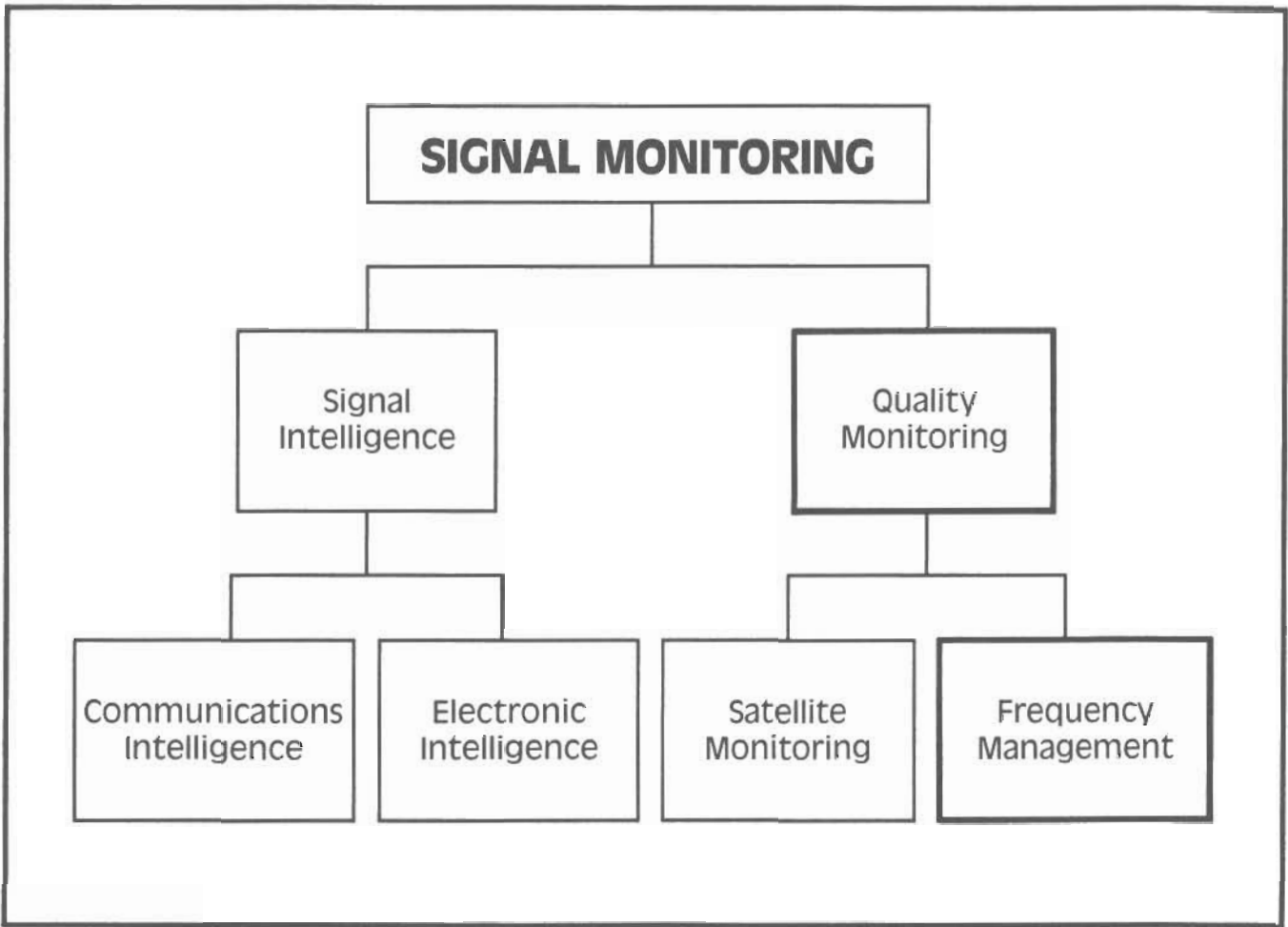

Now let's focus our attention on the final application area, frequency management. Two major aspects of frequency management have been identified, both of which are addressed by the SIGMON receiver system. One is interference control within a communication system, and the other is frequency allocation and the resulting regulation of the allocated spectrum.

INTERFERENCE CONTROL



Key Measurements

- Constantly Monitors the Frequency Spectrum
- Detect Interfering Signal(s)
- Locate Interference

Interference (i.e., an interfering signal) is generated by any number of sources. The objective of a frequency manager is to detect interfering signals, identify the source of each signal, and notify the parties responsible. Let's take an example in which the interfering signals are generated from an uncalibrated transmitter in the area of Kennedy Space Center during the launch of the space shuttle. The frequency spectrum around the space shuttle must be monitored constantly (in this case by a mobile monitoring unit) to insure that no interfering signals are present. The monitoring system must be able to notify the operator if interfering signals appear. Once the signal is detected, the system must then be able to report meaningful data about the interfering signal to the system operator.

FREQUENCY ALLOCATION AND REGULATION



Allocation and/or
Regulation Agency

Pagers
Radio Stations
Police Frequencies
Mobile Telephones
CB Operators
Hand-Held Transceivers

·
·
·

Key Measure

- Band Usage
- Channel Bandwidth
- Site Qualification

Frequency allocation and regulation involve either long-term monitoring of the frequency spectrum in order to determine usages or monitoring a user's transmission parameters to ensure that the transmission meets allocated specifications. A subset of formal allocation concerns site qualification, in which a communication network such as a pager system needs to be set up within an allocated band. The band must be monitored to determine what channels in the area are unoccupied.

Let's take the example of an FM radio station to show how frequency allocation and regulation measurements are made by regulatory bodies. An FM radio station is allocated a particular frequency, bandwidth, and power at which it may transmit. In order to determine if the radio station is conforming to its allocated parameters, the spectrum must be periodically or continuously monitored. If the station broadcasts using too much power or bandwidth, and if there is specific proof to back up such allegations, a fine may be imposed or the station's license may be revoked. The SIGMON receiver system automatically provides the necessary proof of violation.

FREQUENCY MANAGEMENT RECEIVER REQUIREMENT

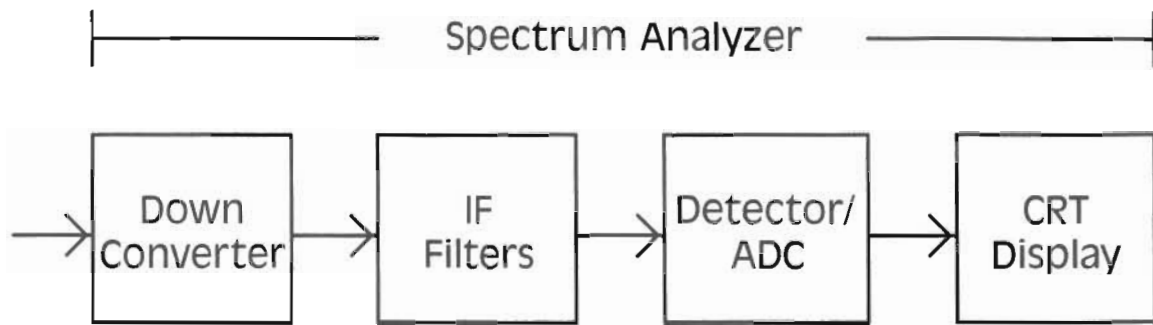

The spectrum analyzer, as a receiver, provides the measurement solution required for frequency management measurements.

MONITOR MULTIPLE BANDS

85865B

MULTIBAND DISPLAY

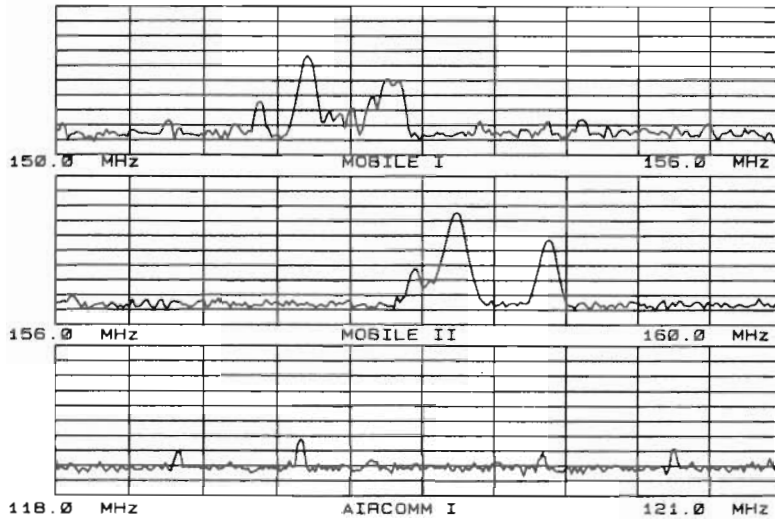

Multiband Display

The SIGMON software allows "n" bands to be monitored sequentially (where "n" is a user-defined parameter). In addition, the graphic capability of high-performance spectrum analyzers enable a user to see up to four different bands at one time on the analyzer's CRT. Again, although the graphic trace must be compressed to fit on the CRT, the measurement resolution of the spectrum analyzer is still intact.

NOTIFICATIONS OF AMPLITUDE AND/OR FREQUENCY VIOLATIONS

.....
DATE 8/14/86 ALARM MATCH DATA
.....

TIME	TYPE	FREQ	VALUE
21: 6: 5: 7	FREQ	151.702 MHz	-60.5 dBm
21: 6:12:21	FREQ	151.702 MHz	-60.3 dBm
21: 6:12:32	AMP	152.050 MHz	-42.4 dBm
21: 6:12:57	FREQ	151.702 MHz	-60.4 dBm
21: 6:12:68	AMP	152.050 MHz	-42.2 dBm
21: 6:12:93	FREQ	151.702 MHz	-60.3 dBm
21: 6:13: 4	AMP	152.044 MHz	-41.9 dBm
21: 6:13:29	FREQ	151.696 MHz	-60.4 dBm
21: 6:13:54	FREQ	151.696 MHz	-60.0 dBm
21: 6:13:78	FREQ	151.702 MHz	-60.1 dBm
21: 6:14: 4	FREQ	151.696 MHz	-60.1 dBm
21: 6:14:28	FREQ	151.702 MHz	-60.1 dBm
21: 6:14:54	FREQ	151.696 MHz	-60.2 dBm

Alarm Match Data

Alarm conditions can be set for amplitude and frequency, corresponding to the power and bandwidth allocation of our FM radio station. The program will then report only signals outside the predetermined values and attach a time and date stamp. This feature not only enables unattended spectrum monitoring but also alleviates having to sift through reams of data.

DETERMINE RELATIVE CHANNEL USAGE

```
RUN TITLE : SANTA ROSA SITE SURVEY  
OPERATOR  : DJM                RUN MODE : MONITOR  
DATE      : 8/14/86  
TIME      : 2:18: 8:33
```

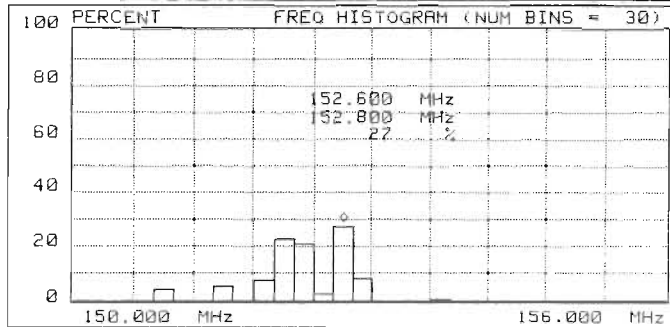

Frequency Histogram

We can use the frequency histogram feature of the SIGMON software to qualify a site and to determine relative signal usage within a band. The horizontal axis can be adjusted so that each bin size represents the width of a communication channel. After monitoring the band, the output can be used directly to determine the occupancy of individual channels relative to total activity within the band.

HOW OFTEN; HOW STRONG; HOW LONG DOES A SIGNAL APPEAR?

TIMEGRAM SUMMARY STATISTICS (VS FREQUENCY)
MOBILE 1
START DATE: 8/13/86, TIME:20:44:36:56
STOP DATE: 8/13/86, TIME:20:50: 3:98
RUN LENGTH = 327 SEC

PERCENT OCCUPANCY (VS FREQUENCY)



MAXIMUM AMPLITUDE (VS FREQUENCY)

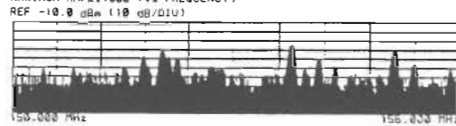

AVERAGE MESSAGE LENGTH (VS FREQUENCY)

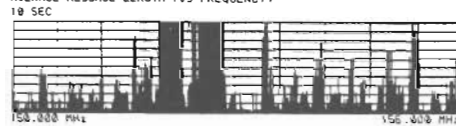

Timegram Summary

If absolute data about a signal or group of signals within a band is required, the timegram summary provides statistics about these signals. The summary is divided into three distinct sections: 1) the Percent Occupancy summary indicates how long each signal was present as a percentage of total run time, with one hundred percent (100%) meaning the signal was always present; 2) the Maximum Amplitude summary gives the maximum amplitude reported for each signal frequency during the run time of the timegram; and 3) the Average Message Length summary shows the average length of time each signal was present, calculated by dividing the number of times a signal appeared into the sum of the length of time of each appearance.

ADDITIONAL SYSTEM FEATURES

- Remote Monitoring
- Customized User Routines
- Task Scheduling
- Data Storage
- Automatically Sort Through Data
- Selective Output Features

In addition to the system features already mentioned, the SIGMON receiver system has additional features applicable to all aspects of signal monitoring. We cannot examine all these features of the system in this presentation; however, we'll briefly touch on the some of the most important ones.

REMOTE MONITORING

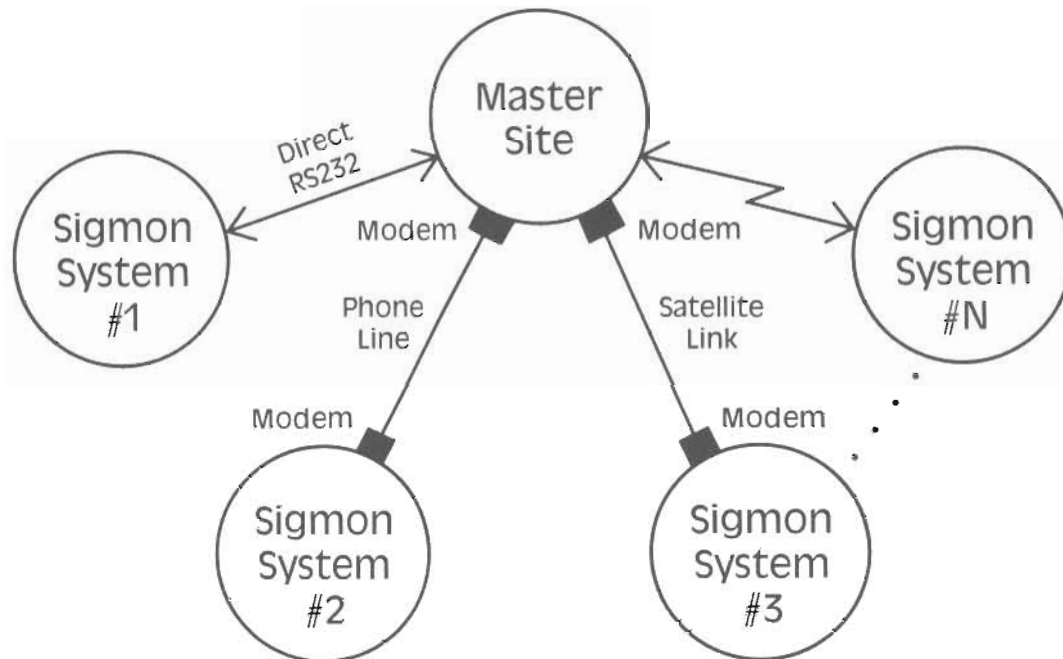

The remote monitoring feature allows a network of SIGMON receiver systems to be tied to a master control station (HUB). A typical remote network consists of a HUB connected to "n" receiver system (SLAVES) sites. The interface between the HUB and each SLAVE is RS-232 supporting various data rates. The connection can be made directly or through modem links, either phone lines or satellites. There is virtually no limit on the physical separation between the HUB and SLAVE sites.

Everything that can be controlled sitting at a conventional SIGMON receiver system controller (except spectrum analyzer manual control) can be controlled by the HUB. Every alpha character displayed on the SLAVE console can be viewed sitting at the HUB. NO GRAPHICS, although displayed on the SLAVE console, is transferred to the HUB. However, stored information can be transferred to the local site for review.

The HUB controller (because of its HP-UX multi-tasking structure) can perform various tasks while the SLAVE stations monitor signals or collect data.

CUSTOMIZED USER ROUTINES

"Myfile"

```
1, RECORD BAND USAGE (SPEC MON)           & ANTENNA
view file cmd '1';                         & VIEW CONTENTS OF FILE
echo 'CONNECT ANTENNA - PRESS <ENTER>';    & USER PROMPT
pause;                                      & PAUSE - <ENTER> CONT'S
mon;                                        & INVOKE MONITOR MODE
assign band 'MOBILE I' 1;                  & ASSIGN "MOBILE I" TO BAND #1
thres ~55;                                 & ADJUST THRESHOLD LEVEL
title 'LAND MOBILE BAND'; operator 'USER 1'; & RUN TITLE AND OPERATOR NAME
disp hist freq;                             & INVOKE FREQUENCY HISTOGRAM
echo 'ENTER "mark hist" FOR MARKER - PRESS SPACE BAR TO CONTINUE';

& NOTE: SPACE BAR CONTINUES
& PROGRAM EXECUTION
```

Printout of a Command File

When measurements need to be performed on a repetitive basis or by persons not familiar with the system, customized user routines can be created and stored. These routines are composed of a string of SIGMON commands that can perform single or multiple tasks. The routines can be loaded and run by an operator or by scheduled operation using the task scheduling feature of the software (discussed in the next slide). If a measurement needs to be performed from 12:00 a.m. until 5:00 a.m., for example, the system can automatically load a routine at 12:00 am, take the necessary data, and shut the system off at 5:00 a.m. When the operator arrives at work the next day, all the required information will have been taken in the user's absence.

TASK SCHEDULING FOR UNATTENDED MONITORING

- Absolute Time and/or Date
do "load 'myfile;'" on 8-4-86 at 00:00:00
- Recurring
do "meas mod;" every 15 sec
- For a Specified Length of Time
do "disp tg;" for 2 hrs then "prt tg summ;"
- Conditionally
repeat . . . until . . . then . . .

This task scheduling capability is one of the most powerful features of the system. The system can be scheduled to perform a task at an absolute time and day (as we saw in the previous slide). If a repetitive task is to be done, the task scheduler can repeat any system function until the program is terminated or the scheduler is cleared. For instance, the modulation of a signal can be measured every fifteen seconds. It is also possible to schedule a task for a fixed length of time. The command shown here displays the timegram to the controller console for two hours and then sends a timegram summary of those two hours to the system printer. If a task is required on a conditional basis only, the task can be placed in a "repeat...until...then" loop. The system will perform the specified task until an event in the system takes place.

DATA STORAGE

Time and Date
Stamped

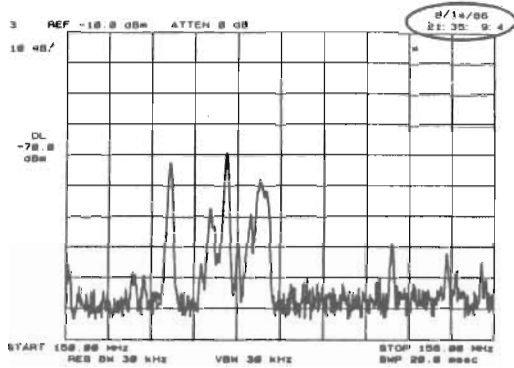

Raw Data
CRT Trace Information

```

*****
RUN TITLE : LAND MOBILE BAND
OPERATOR  : CSF
RUN MODE  : MONITOR
DATE      : 8/14/86
*****
    
```

TIME	FREQ MHz	PWR dBm	TYPE
21:48:40	152.074	-46.6	N
21:48:40	152.260	-51.3	N
21:48:40	152.595	-70.9	N
21:48:40	152.715	-58.9	N
21:48:40	152.905	-60.5	N
21:48:40	152.997	-60.3	N

Signal Data
Tabularized Measured
Parameters

The data storage features of the SIGMON software allow both a spectrum analyzer CRT trace (RAW data) and tabularized, measured data (SIG data) to be stored on a floppy disc drive, hard disc drive, or magnetic tape. Both RAW and SIG data are time and date stamped so that the user can correlate the data with the specific time and day on which the event occurred. A field for descriptive comments can also be added to both RAW and SIG data records as they are stored.

AUTOMATICALLY SORT THROUGH DATA

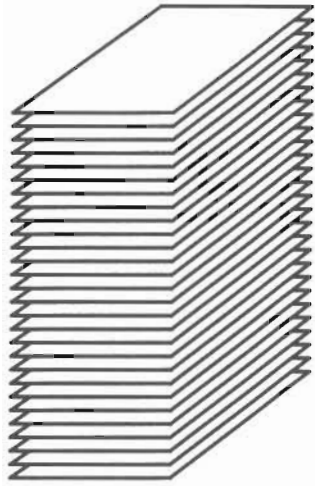

Find Sig (AMP > -40 dBm and Freq < 140 MHz)

Once data has been stored, the database capability allows a user to automatically sort through reams of both RAW and SIG data. RAW data records can be searched for frequency and amplitude parameters while SIG data records can be searched for any measured value. This feature saves the user hours of time by not requiring him to view every data record.

SELECTIVE OUTPUT FEATURES

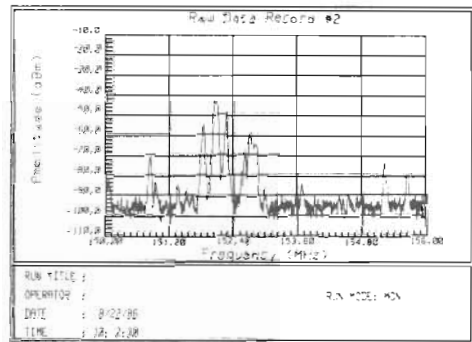
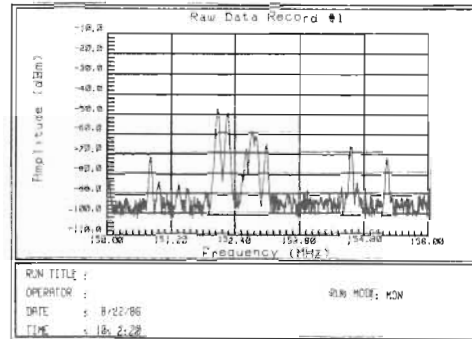
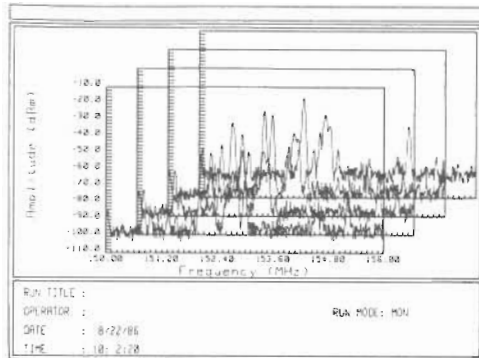

```

-----> SIG DATA RECORD -----
The mode is      : MON
The title is     : REPORT GENERATOR EXAMPLE
The date is      : 85 8 7
The time is      : 15: 7:18:71

The amplitude scale is LOGS

There are 2 signals, and their frequencies are:
                249.552 MHz
                406.502 MHz
  
```

Typically, once the RAW or SIG data has been stored and sorted, the results of the signal monitoring session need to be documented. To aid in this, the SIGMON software allows customization of the output format. The following lists some of the possible outputs: multiple RAW data plots on a single page, falling raster plots, timegram displays, and SIG data output fields arranged as desired.

Conclusion

Signal monitoring is increasing importance in our society due to the number of signals being transmitted in our airwaves. The automatic signal monitoring receiver system described in this paper makes the job of signal monitoring much easier and more efficient. The SIGMON receiver system can run unattended, thereby freeing up valuable manpower for other tasks; it contains an off-the-shelf spectrum analyzer which can also be used as general purpose test equipment; and it can be used to interface with more specialized equipment. The SIGMON software not only automates the spectrum analyzer but also provides graphic displays and database features to aid the user with his specific measurement tasks.

